

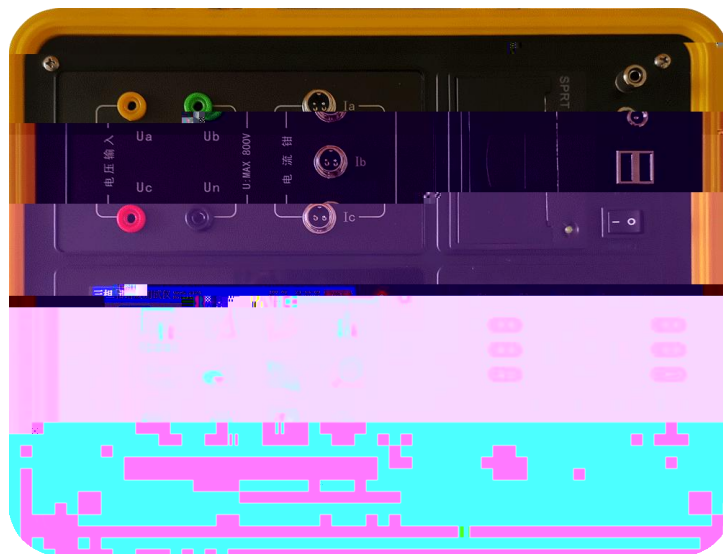

慎重保证

1. 安全要求

—防止火灾或人身伤害

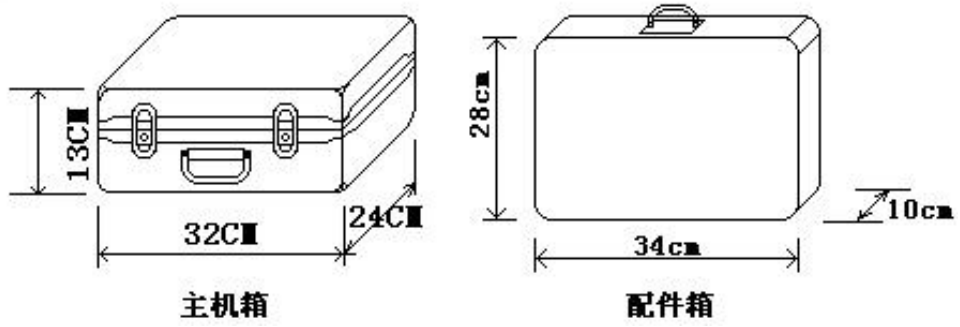

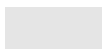
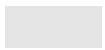
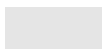

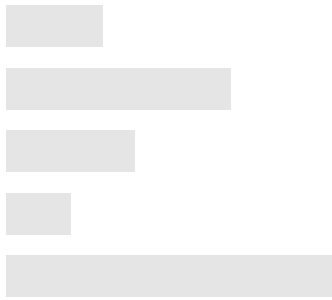

É



•



•



•



•



•



•



•



•



•

•



•



电能质量测试仪		Ver3.000		57.74V		13-01-15		5A_q		14:20:40	
No:12345											
THD	0.00%	0.00%	0.00%	0.00%	0.00%	0.00%	0.00%	0.00%	0.00%	0.00%	0.00%
TMS	0.00V	0.00V	0.00V	0.000A	0.000A	0.000A	0.000A	0.000A	0.000A	0.000A	0.000A
01	0.0	0.0	0.0	0.000	0.000	0.000	0.000	0.000	0.000	0.000	0.000
02	0.0	0.0%	0.0	0.0%	0.0	0.0%	0.000	0.0%	0.000	0.0%	0.000
03	0.0	0.0%	0.0	0.0%	0.0	0.0%	0.000	0.0%	0.000	0.0%	0.000
04	0.0	0.0%	0.0	0.0%	0.0	0.0%	0.000	0.0%	0.000	0.0%	0.000
05	0.0	0.0%	0.0	0.0%	0.0	0.0%	0.000	0.0%	0.000	0.0%	0.000

按【F1】浏览 【上下】数据翻页 【退出】返回



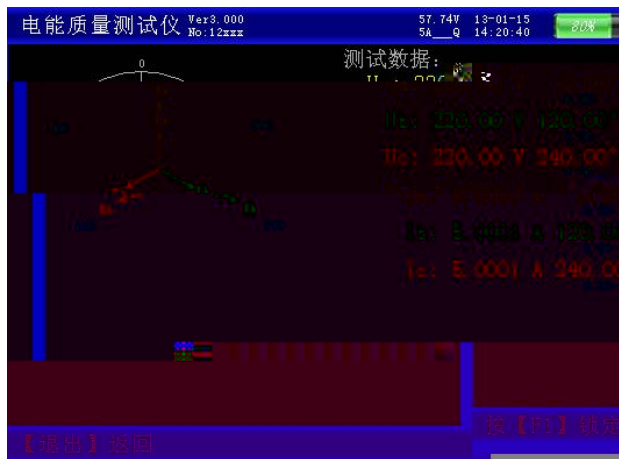
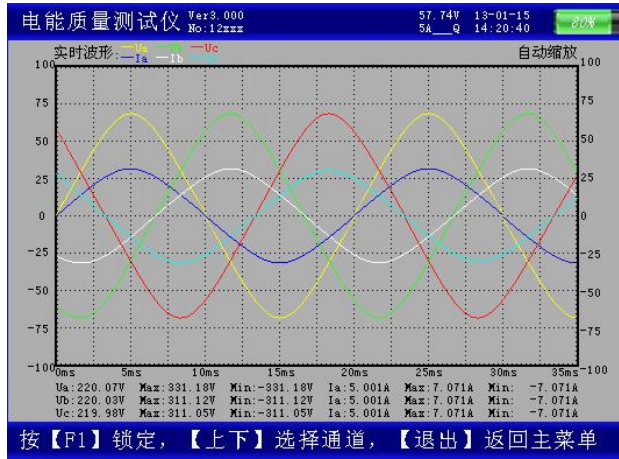



电能质量测试仪 Ver:3.000 No:12zzzz			57.74V 13:01:15 5A__9 14:20:40		
额定电压:10.00kV		短路容量:100.00MVA			
供电容量:100.00MVA		协议容量:100.99MVA			
次数	电流	电压	次数	电流	电压
02	26.00A	1.60%	14	3.70A	1.60%
03	20.00A	3.20%	15	4.10A	3.20%
04	13.00A	1.60%	16	3.20A	1.60%
05	20.00A	3.20%	17	6.00A	3.20%
06	8.50A	1.60%	18	2.80A	1.60%
07	15.00A	3.20%	19	5.40A	3.20%
08	6.40A	1.60%	20	2.60A	1.60%
09	6.80A	3.20%	21	2.90A	3.20%
10	5.10A	1.60%	22	2.30A	1.60%
11	9.30A	3.20%	23	4.50A	3.20%
12	4.30A	1.60%	24	2.10A	1.60%
13	7.90A	3.20%	25	4.10A	3.20%

按【退出】返回主菜单





