YTC720





—

.....	5
.....	5
.....	5
.....	6
.....	6
.....	6
.....	7
.....	8
.....	8
.....	8
.....	9
.....	10
.....	14
.....	18
.....	19

YTC720

SJ-255-10300

USB

800X640

USB

PC

1.	C	2.	U	3.	I	4.	F	5.	P
		7.	XC	8.	R	9.		6.	Q

1.	L	2.	U	3.	I	4.	F	5.	P
		7.	XL	8.	R	9.		6.	Q

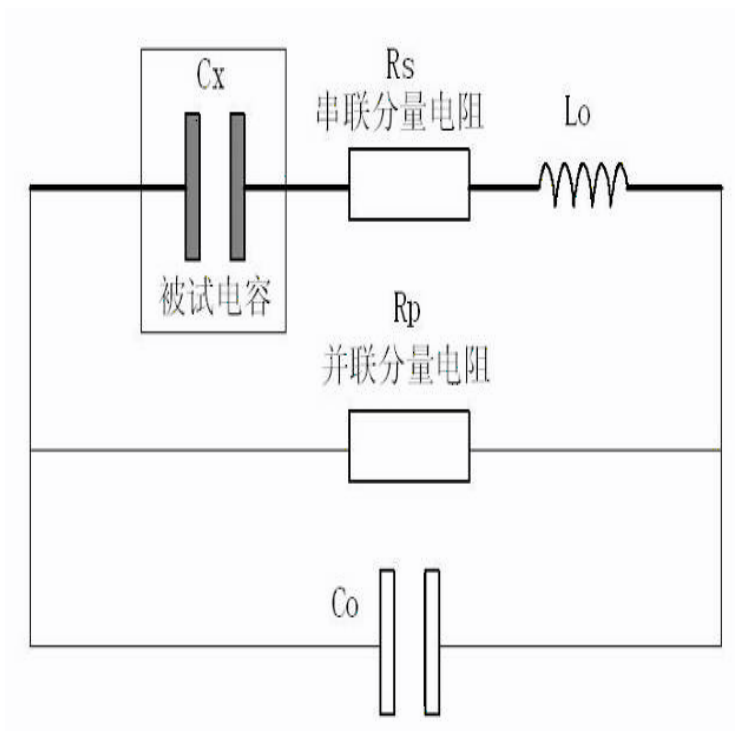

Lo

Rp

Co

Cx

Rs

1

" "

"

" ; (2)

RC

-10 +40

90%

220V ± 10%

50Hz

22V/25A/500VA

420 × 170 × 340mm × ×

10kg

(1)	0.010μ F 0.200μ F;	± 0.5%
(2)	0.200μ F 2.000μ F;	± 0.5%
(3)	2.000μ F 20.00μ F;	± 0.5%
(4)	20.00μ F 200.0μ F;	± 0.5%
(5)	200.0μ F 3300. μ F;	± 0.5%

	0 20.00Mvar		± 1%
	0 20.00kW		± 1%
	0 20.00%		± 1%
	0 10.00M		± 1%
	10m 200k		± 1%

(1)	0.10mH 0.200H	± 0.5%
(2)	2.000H 20.00H	± 0.5%
(3)	20.00H 200.0H	± 0.5%
(4)	200.0H 2000. H	± 0.5%

	0 20.00Mvar		± 1%
	0 20.00kW		± 1%
	0 20.00%		± 1%
	0 10.00		± 1%
	10m 200k		± 1%

(AC)	
------	--

0.000mA	50.00A	$\pm 0.2\%$
---------	--------	-------------

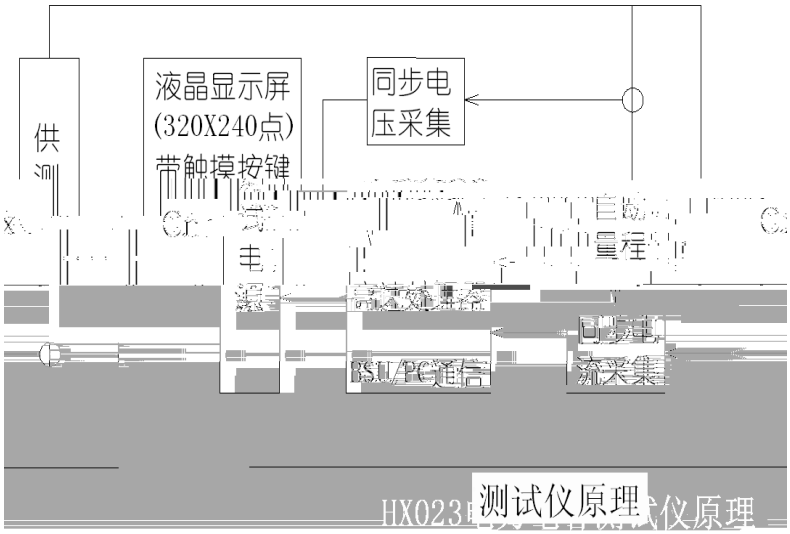

16 AD

1

U		U	
I		I	
F		F	
C		L	
R		R	

XC		XL	
Q		Q	
P		P	



800X600

USB

U

5A

2

5V/40A

25V/10A



(Y ()

Y

Yn

1.Y

Y A

1 Y A

A

B

A

Y

A

1

Y B

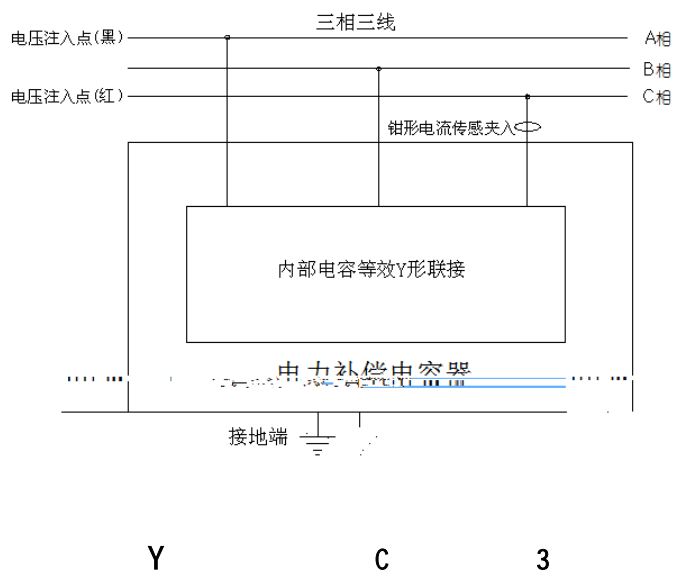

Y C
3 Y C
C
A
C

2

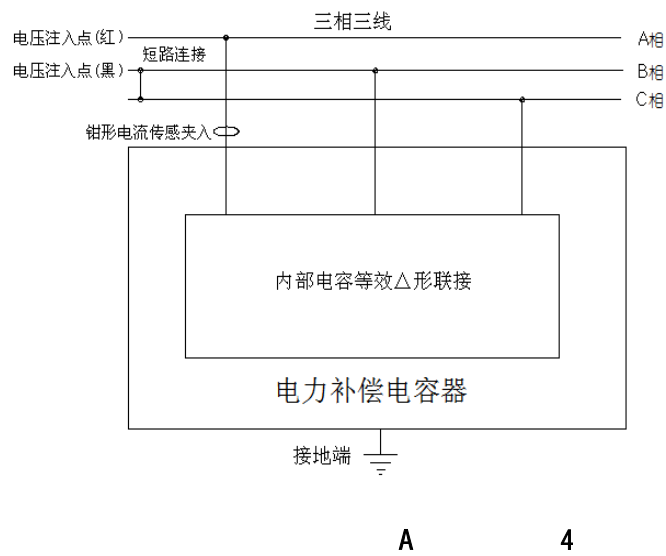

A
4 A
A BC
A
B

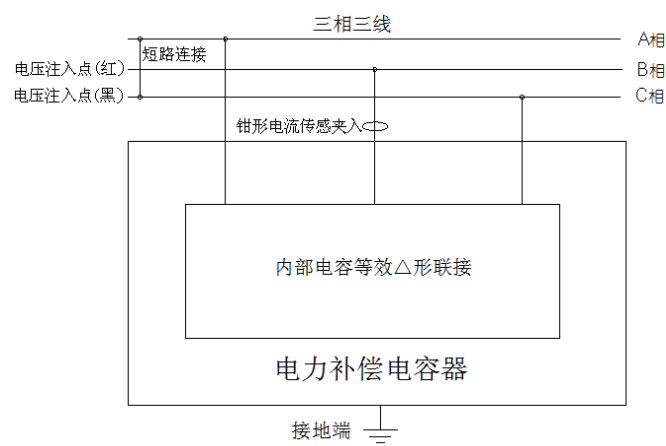

B
5 B
B

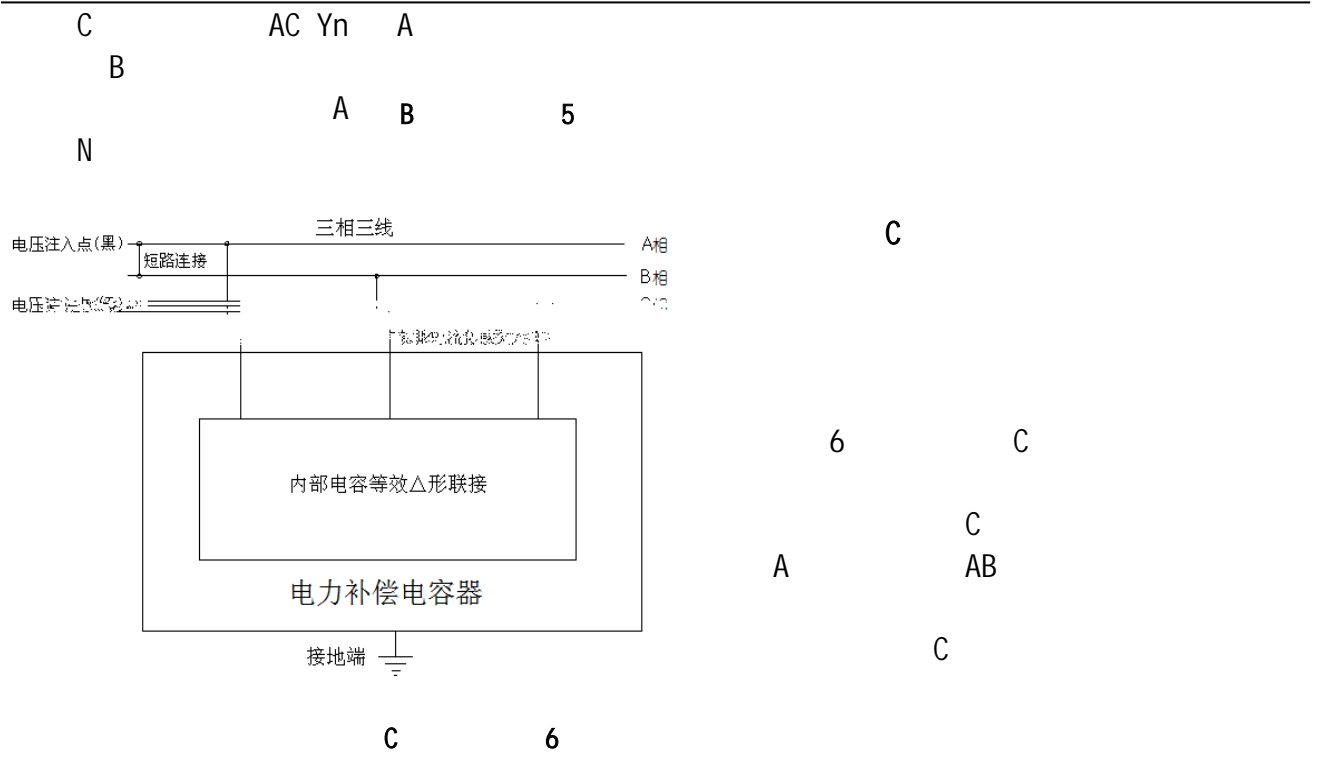

3. Yn

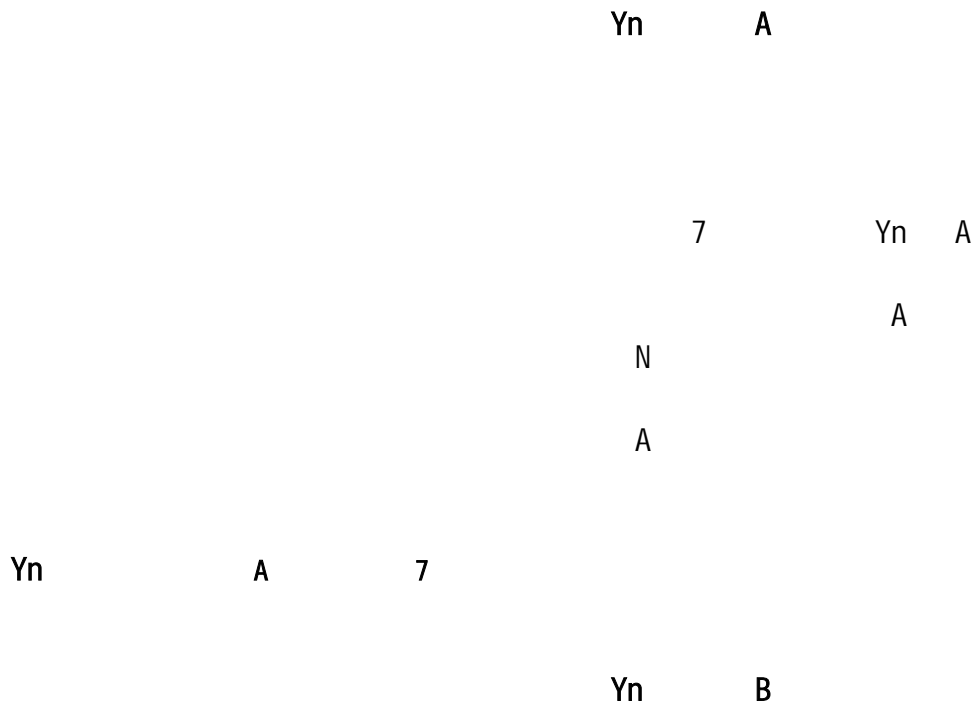

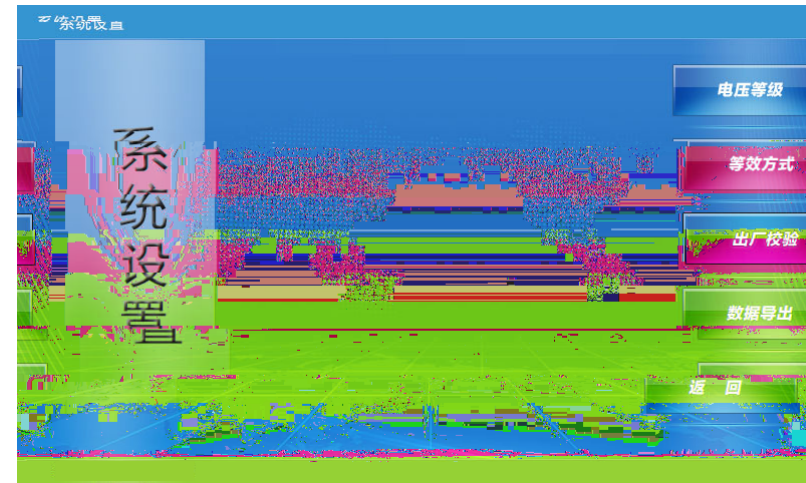
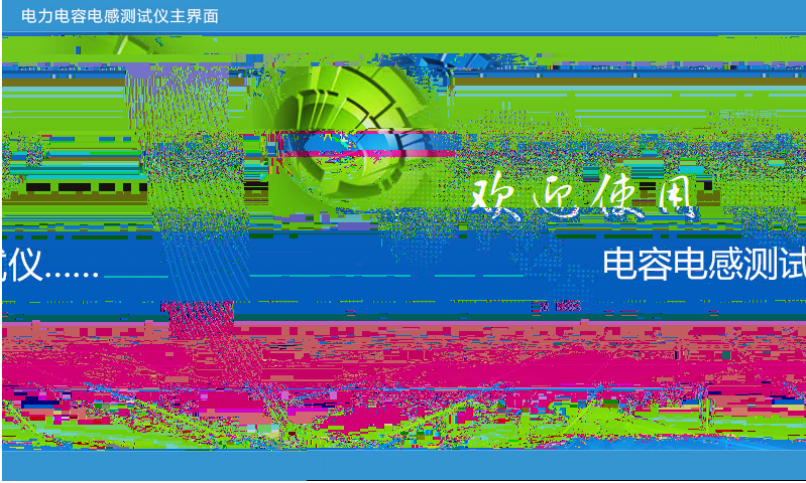

“ ”

“ ”

“ ”

“ ”

“ ”

“ ”



“ ” “ ”
 “ ”
 “ ”



“ ”
 “ ”
 “ ”



“ ” U U
 USB
 “ ”
 “ ”

" "

" "

" "

" "

.....

Y

" " B

3

" " A

" " B

" " C



1 20

" "

" "

" "

" "

" "

" "



" "

" "

" "

" "

" "

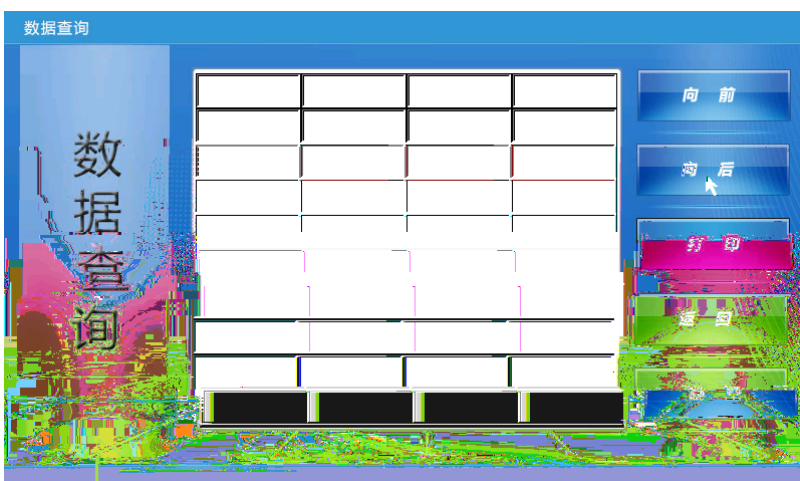

/

" " " "

" "

" "

" "

.....

	1		1
	2		1
	1	5A 250V	2
	1		1
	1	3 μ F	1

, -10 60 , 90 ,

