

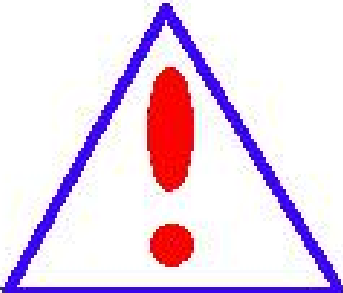

YTC8750C

YTC8750C





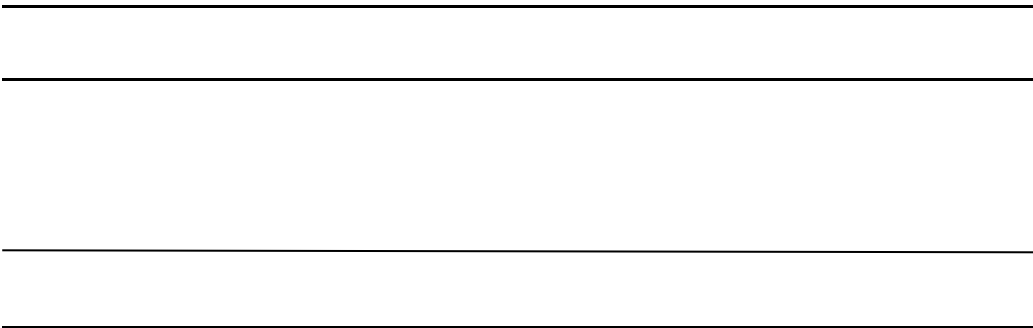

YTC8750C

www.hb1000kv.com

YTC8750C

全自动型测试仪

-----GT/PT " " 5 10 15 " " " "

" m x

\\ \\\ \\\ \\\ \\\



5



CT	220V	0—1000V	20A	3KVA	< 0.5%
PT	220V	0—330V		3KVA	< 0.5%
CT	220V	0-8V	0—600A		< 0.5%
PT	220V	0—1000V			< 0.5%
CT	999.9K: 5/1				< 0.5%
PT	999.9K: 100 150 100/3 100/ 3				< 0.5%
	0-20				< 0.5%
	0.01	± 5		0.01%	<0.5%
	0-200A	5		0-1000V	5
	-10	55		AC220V ± 20	50HZ
	350× 240× 270			20Kg	

- 1.
- 2.
- 3.
- 4. PC
- 5. U
- 6.
- 7.
- 8.
- 9. +
- 10.
- 11. PT
- 12. / /PT / CT
- 13. CT

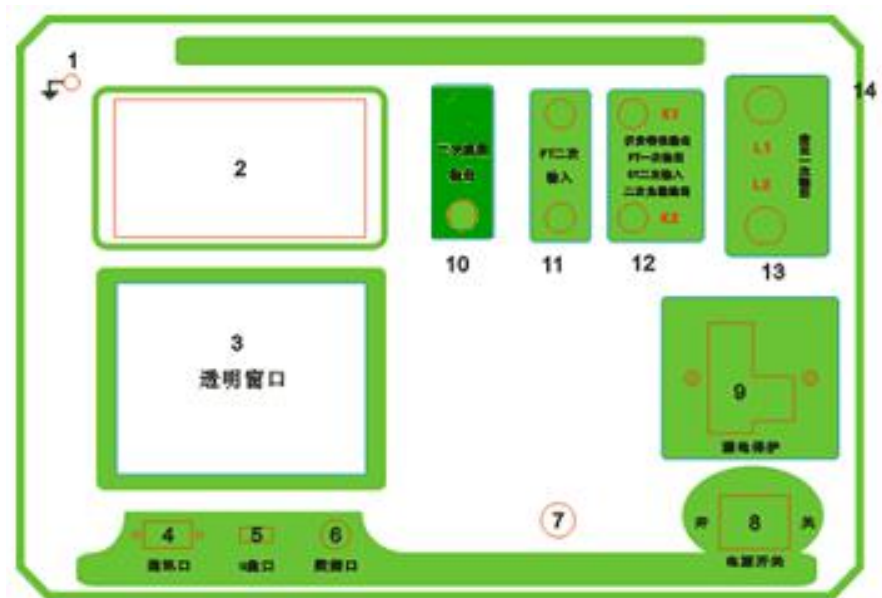

14. 220V ± 10

1.

" " " " " "

" "

2.

220



3. CT

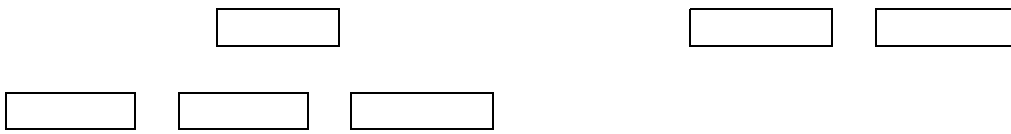

A.

:

CT

CT 参数设置	
编号:	<u>ABC001</u>
相序:	<u>A</u>
Kn:	<u>1</u>
变比:	<u>1000:5</u>
<input type="button" value="确定"/>	

B.

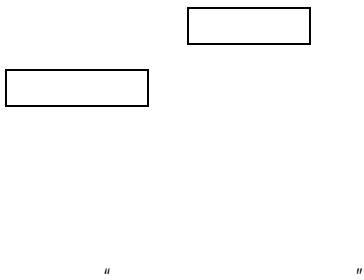

8

二次直阻测试	
二次直阻: 0.320 ohm	
<input type="button" value="打印"/>	<input type="button" value="返回"/>

C. CT

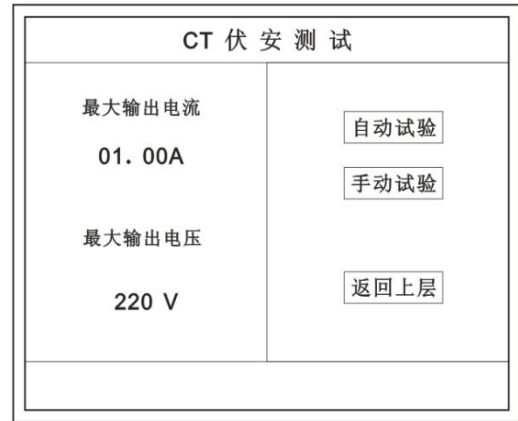
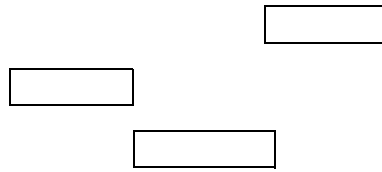

a.



0 - 15

30 110 220 600 1000

b.

CT

c.

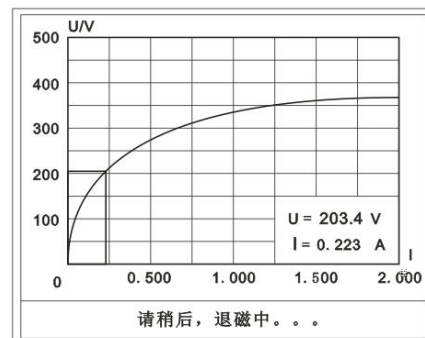
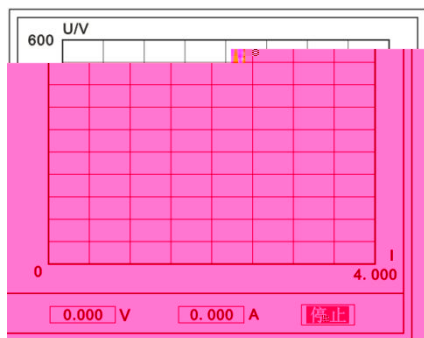

d.

(_____)

e.

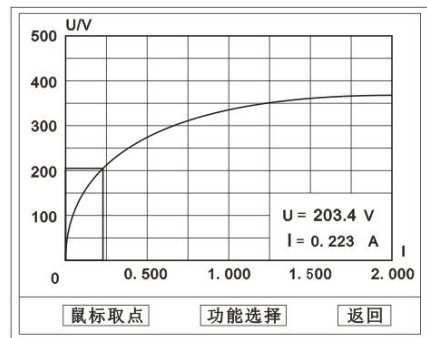

◆

◆

◆

◆

 5 10 15

D. CT

a.

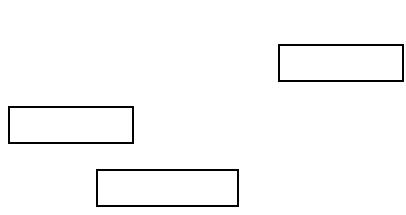

CT 变比测试

一次输出电流 600A	<input type="button" value="自动试验"/> <input type="button" value="误差试验"/> <input type="button" value="二次回路"/> <input type="button" value="返回上层"/>
-----------------------	--

0 - 600

1 5 20 100 120

5 200A

b.

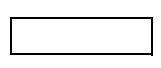

c.



一次侧：400.0 A	
二次侧	0.400A
比值	5.000K:5
角差	1.83'
比差	0.00%
极性	同相/—

保存 打印 返回

CT



d.

1 5 20

100 120

CT 误差试验		
	角差	比差
1%	40.3'	1.30%
5%	12.6'	0.30%
20%	1.32'	0.00%
100%	0.83'	0.00%

e.

5 200A

CT测试——二次回路
一次电流：150.3 A

累计时间 0: 56 打印 返回上层

E.



二次负载测试
二次阻抗：1.242

4. PT



CT CT

A. PT

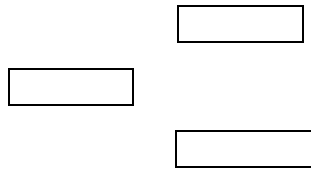

PT 伏安测试	
最大输出电流	<input type="button" value="自动试验"/>
01.00A	<input type="button" value="手动试验"/>
最大输出电压	<input type="button" value="返回上层"/>
150 V	

a.



0 - 3
0 330

b.



B. PT



a.



0 - 1000



b.



5

PT

a x

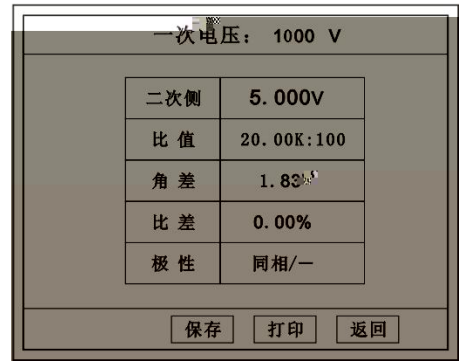

c.

5

1000V



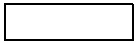

A.

B.

C.



0 1000V
K1 K2 0 15A
10 15A 1

精度对比	
输出电压 220 V	<input type="button" value="电压精度"/>
	<input type="button" value="电流精度"/>
	<input type="button" value="返回上层"/>

电流精度对比
当前电流: 1.300 A
<input type="button" value="停止试验"/>

电压精度对比
当前电压: 150.3 V
<input type="button" value="停止升压"/>

1. CT

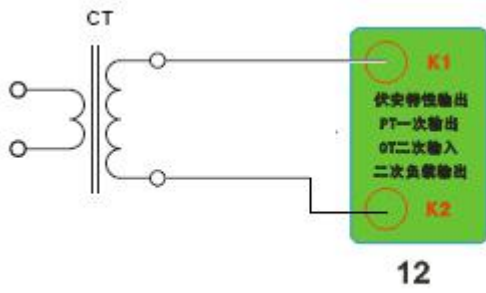

2. CT

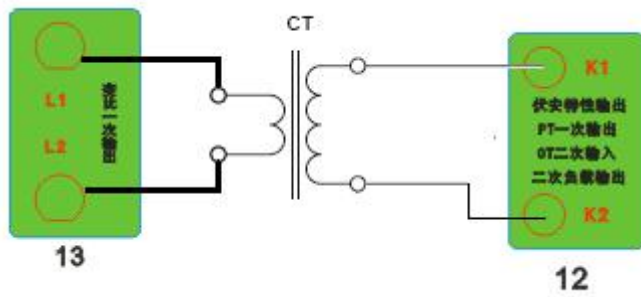

3.

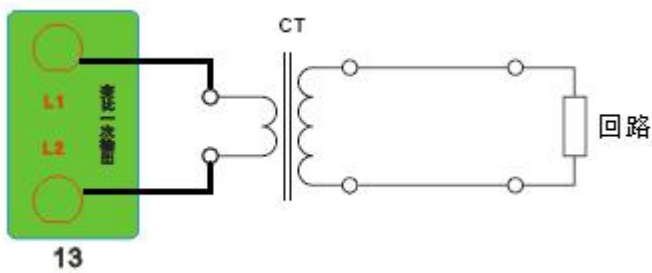

4. PT

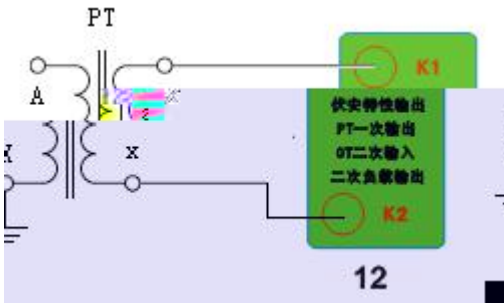

5. PT

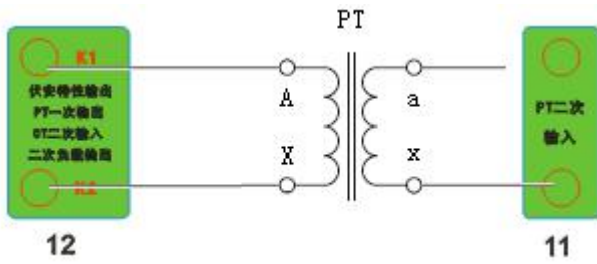

6.

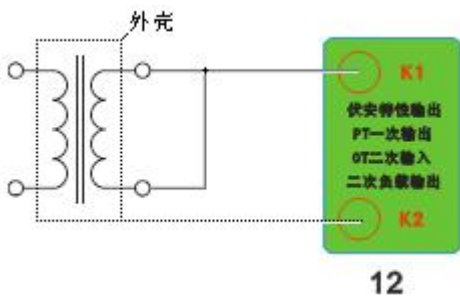

7.

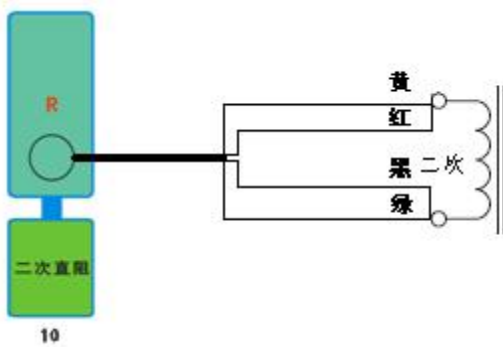

8.

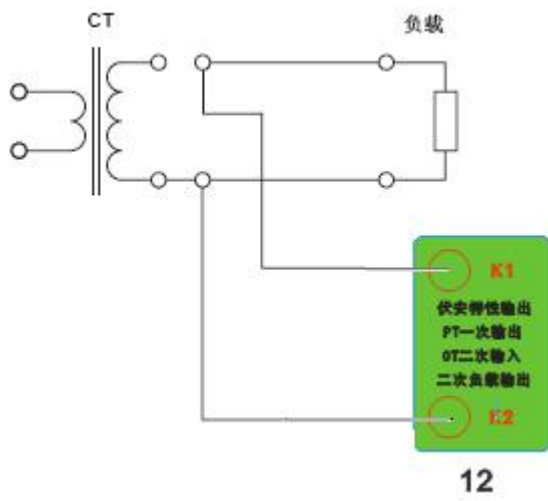

1.

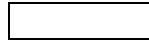

2.

1.

2.

3.